

KULLANIM KILAVUZU OPERATIONAL MANUAL

LÜTFEN BU KİTAPÇIĞI DİKKATLİCE OKUYUN.
KİTAPÇIKTA ÖNEMLİ GÜVENLİK BİLGİLERİ
BULUNMAKTADIR.

PLEASE READ THIS BOOKLET CAREFULLY.
THE BOOKLET CONTAINS IMPORTANT SAFETY
INFORMATION.

www.kamabyreis.com

BENZİNLİ JENERATÖR SETİ GASOLINE GENERATOR SETS

MONOFAZE / SINGLE PHASE (220V)
KGL3500C, KGL3500CE, KGL8000CE

TRİFAZE / 3-PHASE (400V)
KGL8000CE3

















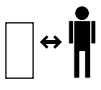

CONTENTS

1.SAFETY TIPS.....	31
2.PARTS AND COMPONENTS INTRODUCTION.....	33
3.INSPECTION BEFORE OPERATION.....	34
4.STARTING THE GENERATOR.....	37
5.ELECTRIC CONNECTING.....	38
6.STOPPING THE GENERATOR.....	41
7.REGULAR INSPECTION AND MAINTENANCE.....	42
8.STORAGE OF GENERATOR.....	45
9.TROUBLE SHOOTING.....	46
10.ELECTRIC DIAGRAM.....	48

ATTENTION

1. Kids should be kept in safe distance to generator.
2. Don't touch the engine and muffler while generator is working or just be turned down to avoid empyrosis. Please pay attention to warning sticker on generator.
3. Electrical equipment (including cable and plug connecting component) should be in good condition before starting.
4. New circuit breaker must be under same level performance, characteristic and parameters with the former for replacement.
5. Due to high mechanical stress, only rubber sheath cables or parity products are allowed to be used.
6. When using extension wire or mobile distribution cabinets, wire with 1.5 square millimetre cross section should not be longer than 60 metres; for 2.5 millimetre cross section, wire should not be longer than 100 metres.
7. With the engine of manual starting, the danger of change rotating direction suddenly should be prevented.
8. On standard working condition of circumstance, the generator could only load on rated output. If the working condition of circumstance is not standard, the generator should be run at lower output. When temperature, altitude and humidity is higher than standard working condition of circumstance, the generator would reduce the output.
9. Before checking and maintenance of generator, the engine must be stopped. To disassemble the spark plug and key starting to make sure the engine would not be started improperly. Then check and maintain the generator on the scheduled calendar of repair.
10. Except the daily maintenance and cleaning, the checking and readjustment should be conducted by authorized professional person and source the requested components by them. (contact with local dealers).
11. The new or just overhauled machine must endure the breaking-in period at 30hours at least, the output should not exceed 75% of rated output.

THE IMPORTANCE OF THE SECURITY LABEL

	caution		risk of electric shock
	stay away from the heat source		do not remove the pads moving parts
	read before using the user manual.		do not use in the rain. do not wash with water jet
	earthing terminal		do not use in a non ventilated the risk of death
	conduct interviews		don't put out a fire oil and water
	- safety distance		toxic exhaust gas the risk of death
	protection against the noise)		HOT SURFACE
	don't let a child without surveillance autour de l'appareil around the device		Do not spill out when fueling. Remember to stop generator before fueling.
	within the e u, this symbol indicates that this product is not on the waste can be disposed of. contain valuable recyclable waste materials, a recycling should be channelled towards and around the environment and the human health from uncontrolled waste disposal not to damage. please dispose of waste therefore, appropriate collection systems or send the device to dispose of the body when you bought it. this is the device of recycling.		
	ne pas brancher d'électronique machines		

INTENDED USE / NOT INTENDED USE

The machines are portable generators with a four-stroke gasoline engine, with AC, 50Hz / 60Hz and 12V DC output for domestic use.

The gasoline generator set is suitable for temporary power supply. It may only be operated in a well ventilated area. The product is intended for household use in accordance with the instructions, all other applications, such as commercial exploitation, are specifically excluded. For damage or injury resulting from an abuse, the user / operator liable and not the manufacturer. Part of the intended use is also the consideration of the safety and operating instructions in the manual.

Persons who should operate this machine will be familiar with the instructions and the possible dangers. In addition, the existing safety rules are strictly observed. Other general rules of safety and security areas are respected. Changes to the machines, including the liability of the manufacturer and any damage from this set, the warranty expire. The machine must only be operated outdoors or in a ventilated room.

RESIDUAL RISKS

Even when properly used the machine is always some residual risk that can not be ruled out. Because of o.g. Use, construction of the machine can be derived during the use if the following potential hazards.

Inhalation of fumes (poisoning danger)

- Avoid contact with hot surfaces / exhaust system (burns)
- Impairment of hearing for non-adherence to the prescribed hearing protection
- Contact with petrol / oil and the skin
- Inhalation of gasoline fumes
- Contact with the coming-promoting medium

1. SAFETY TIPS



◀ Never operate the generator in door or in a poor-ventilated area.

▶ Do not operate the generator Under wet climate(rain,snow).



◀ Never connect to house power circuit if commerial power supply is not cut.

▶ Keep at least 1 m (3ft) away from inflammables.

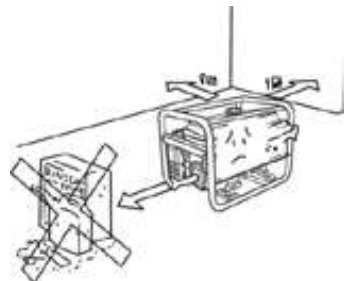



◀ Do not smoking when fueling.

▶ Do not spill out when fueling.



◀ Remember to stop generator before fueling.

Others:

- Do not touch the muffler or muffler cover while the engine is running or still hot.
- Do not touch the generator when either it or your hand are wet, avoid short circuit or electric shock.
- Never permit anyone to operate the generator without proper instruction.
- Always wear safety shoes and proper cloths.
- Keep children and pets away from the generator when the generator is in operating.

2. PARTS AND COMPONENTS INTRODUCTION

Model:unit

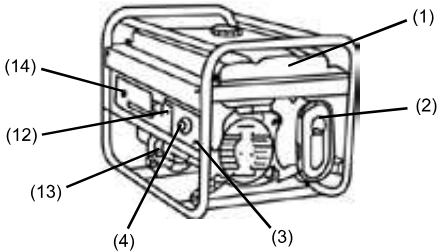

- (1) Fuel tank
- (2) Muffler
- (3) Earth terminal
- (4) AC socket/plug
- (5) Carburetor throttle lever
- (6) Starter handle
- (7) Fuel cock

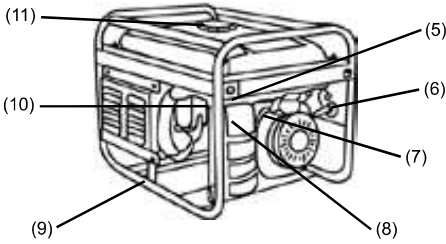

- (9) Pipe frame
- (10) Spark plug
- (11) Fuel tank cap
- (12) Breaker
- (13) Oil gauge Dipstick
- (14) Starter switch
- (15) AC protector

Model:Simple unit

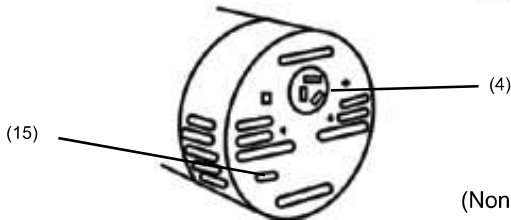
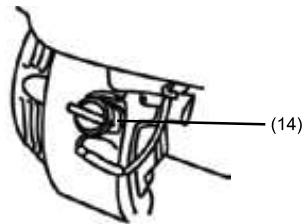
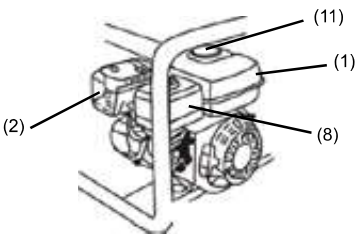

(Non-frame model)

3. INSPECTION BEFORE OPERATION

34-1. Lube Oil

Always check the oil level before start
The stooping generator on a level place.

- ① Turn out the oil filter gauge (dipstick) and clean it with a clean cloth.

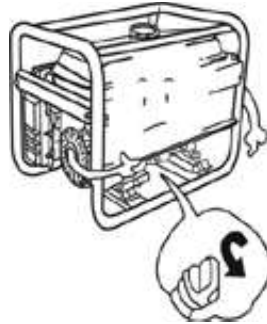

- ② Insert the dipstick back without screw in, and check the oil level.

- ③ In the case that the oil level is below the lower mark of the dipstick, refill the oil to the upper mark.

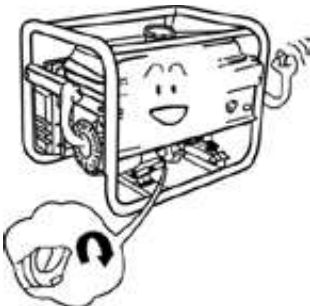
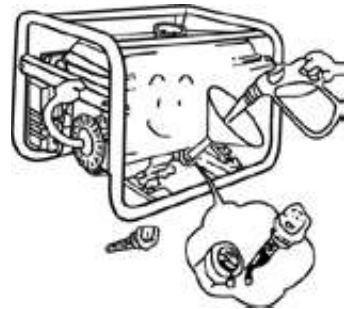

- ④ Reinstall the dipstick.

3-2. Fuel

① Open the fuel tank cap.

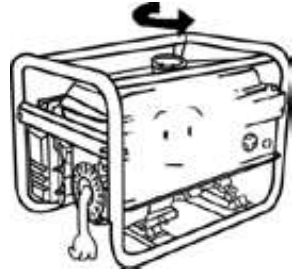

② Check the fuel level, and refuel if necessary.



③ Refuel up to the shoulder of the fuel fillter.



④ Reinstall the fuel tank cap.

3-3. Air Cleaner

- ① Loosen the clip and remove the air cleaner housing. (For model: CL)
Loosen the wing-nut and remove the air cleaner cover. (For model: C)

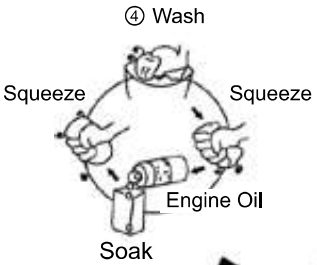
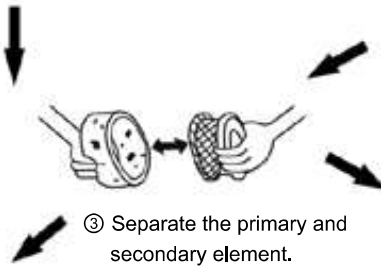
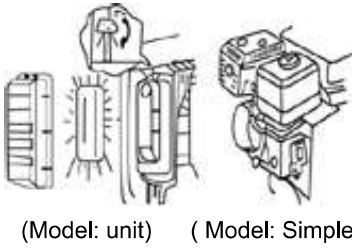

- ⑤ Tap the element or use compress air to blow from inside.

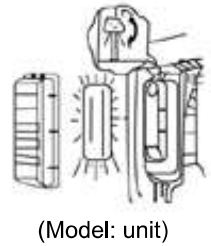

4. STARTING THE GENERATOR

5-1. Remove all the loads from ACsocket and switch off the BREAKER.

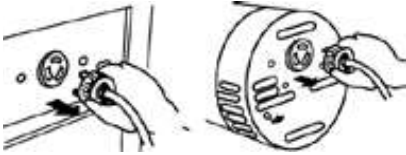

(Model: unit, Simple unit)

5-2. Set the fuel cock to "ON" position.

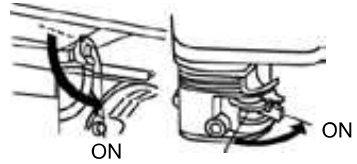

(Model: unit)

(Model: Simple unit)

5-3. Push the choke lever to "CLOSE" position.

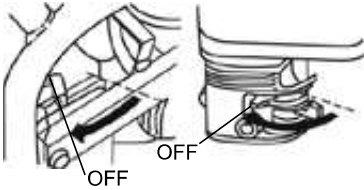

(Model: unit)

(Model: Simple unit)

5-4. Turn the engine switch to "ON" position.

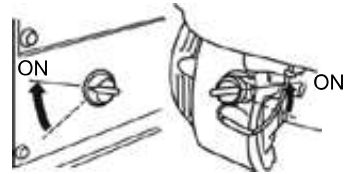

(Model: unit)

(Model: Simple unit)

5-5. Pull the starter handle until resistance is felt, then pull it out swiftly from original position.

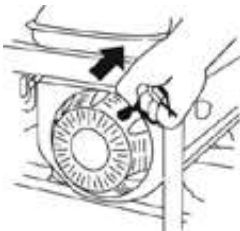

5-6. Once the generator starts, gradually turn the choke lever to "ON" position.



(Model: unit)

(Model: Simple unit)

5. ELECTRIC CONNECTING

⚠ CAUTION





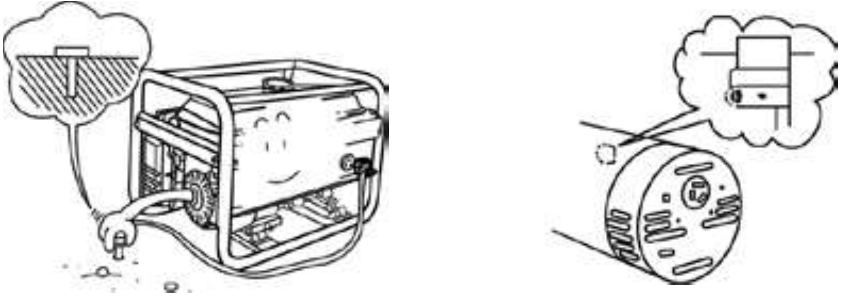



★ To keep the generator in the best running and electric condition, please obey the follows:

5-1. Ground the generator to prevent electric shock:



(Model: unit, Simple unit)

5-2. Refer some appliance for electric consumption:

Type	Wattage		Appliance	Sample		
	Starting	Rated		Appliance	Starting	Rated
Electric bulb or heater	X1	X1	 Electric bulb  TV	 Electric bulb 100W	100VA(W)	100VA(W)
Day light lamp	X2	X1.5	 Day light lamp	 40W Day light lamp	80VA(W)	60VA(W)
Motor Drive	X3-5	X2	 Refrigerator  Electric fan	 Refrigerator 150W	450-750 VA	300VA(W)

5-3. If the generator is supply more than 2 appliances, be sure to start them one by one with the highest current first.

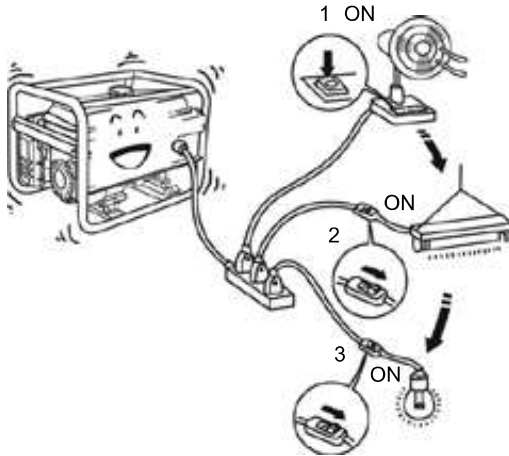

CAUTION: Do not connect the generator to home power circuit. When this connection is necessary, be sure that a skilled electrician does the job. Improper connecting between the generator and home power circuit may cause damage of the generator, and even fire accident.

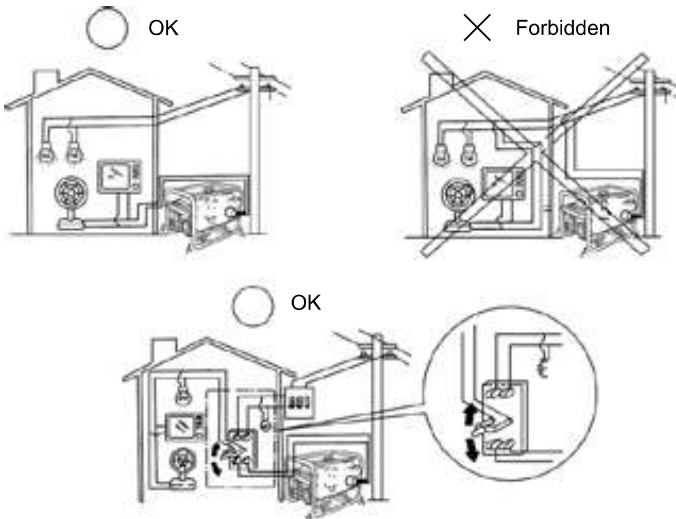

5-4. AC electric connecting

1. Starting the generator.



2. Connecting the appliances.



(Model: unit, Simple unit)

3. Turn on the BREAKER or push down the Ac protector.

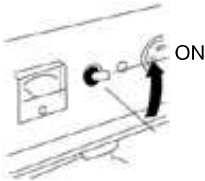

5-5. DC Application

The DC terminal may be used for charging 12V automotive-type batteries only.

- ① When using automotive-type batteries with battery cables, be sure to disconnect the minus pole battery cable from the battery before charging.
- ② Connect the charging cable to the battery terminals and the DC terminal of generator.
 - Connect the positive battery terminal to the positive generator terminal.
 - Do not reverse the charging cables, or serious damage to the generator and/or Battery may occur.
 - Do not allow the free ends of the cable to touch each other, if this occur, it will be short circuit the battery.
 - When a large capacity battery is charged, excessive current flows (the value varies depending on the discharged condition), and the fuse for DC current will burn out.
- ③ Batteries produce explosive gases. Keep sparks, flames and cigarettes well away.
- ④ To prevent the possibility of creating a spark near the battery, always connect charging cables to battery first and only then to the generator. When disconnecting, you should disconnect the cables at the generator first.
- ⑤ Charge the battery in a well ventilated place.
- ⑥ Before charging, remove the cap from each cell of the battery, Discontinue charging if the electrolyte temperature exceeds 45°C.

6. STOPPING THE GENERATOR

6-1. Turn off the Breaker.

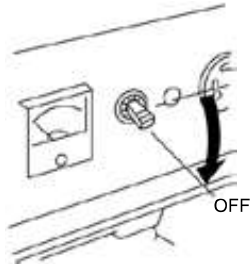

(Model: unit, Simple unit)

6-2. Turn off the engine switch.

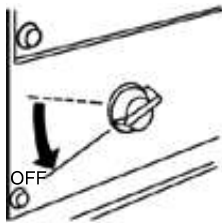

(Model: unit)

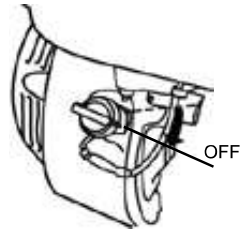

(Model: Simple unit)

6-3. Turn off the fuel cock.

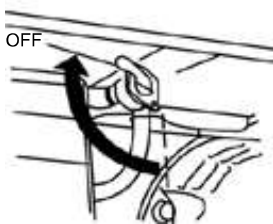

(Model: unit)

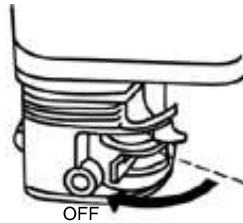

(Model: Simple unit)





NOTE: In emergency, turn the engine switch to "OFF" to stop the generator.





















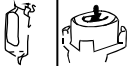





⚠ WARNING Never stopping the generator at high speed under heavy load, otherwise, the damage will result.

7. REGULAR INSPECTION AND MAINTENANCE

⚠ CAUTION

Daily and regular inspection is important to assure safe, proper and long-term operation of the generator. Refer to the regular inspection table when conducting inspection and maintenance.

Inspection  Replace  Cleaning  Adjustment 

		 Daily check	 20hrs or first month	 50hrs or every 3 month	 100hrs or every 6 month	 300hrs or every 1 year	Refer page
Lube oil check							P.4
Replace engine oil							P.5
Air cleaner check							P.6
Air cleaner wash							P.6
Fuel filter cup							P.5
Fuel filter							P.5
Spark plug							P.14
Value clearance							-
Cylinder cover wash							-
Fuel tank wash		Every 2 years or when necessary.					-

7-1. Engine oil replacement

- ① Loosen the oil drain plug crankshaft.

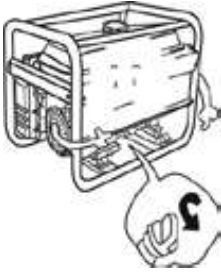

- ② Drain off the engine oil in the and dipstick.

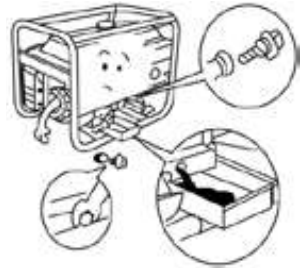

- ③ Screw in and tighten the drain with seal washer.

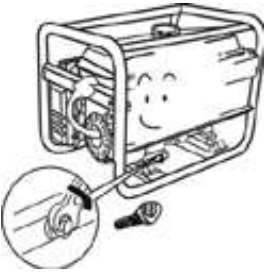

- ④ Filling the engine oil to the upper plug level.

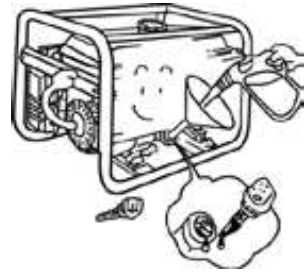

- ⑤ Reinstall the dipstick.

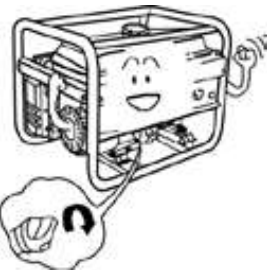

Recommended Engine oil:

4-stroke gasoline engine oil SF, SF from API Service Classification or SAE 10W-30 equivalent to SG Class.

In Frigid Ambience Temperature

(below -15°C)

SE.SF from API Service Classification or SAE5W-30 equivalent to SG Class.

7-2. Spark plug cleaning

① Dismantle the spark plug cap.

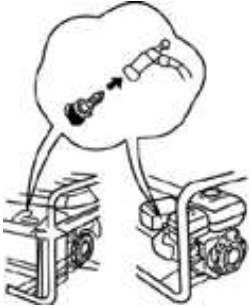

(Model: unit)

(Model: Simple unit)

② Dismantle the spark plug.



④ Measure the electrodes clearance.

0.7-0.8mm

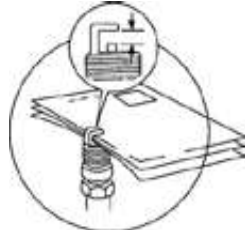

③ Clean away carbon sediment.



⑤ Reinstall the spark plug and cap.



7-3. Spark plug cleaning

① Set the fuel cock to "OFF" position, and dismantle the filter cup.

a. Dismantle the fuel filter.

(Model: unit)

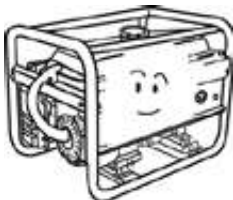

b. Dismantle the fuel filter cup.

(Model: Simple unit)



② Clean the fuel filter with air blow from inside.

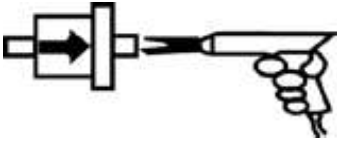

③ Clean the fuel filter cup thoroughly.



④ Mount a new rubber ring and the filter cup securely.

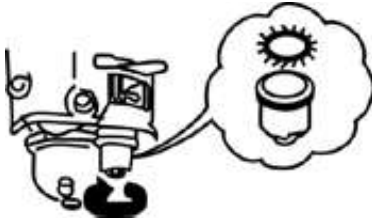

8. STORAGE OF GENERATOR

If the generator should be stored for a long time (more than 30 days), the following preparation should be made.

8-1. Turn the fuel cock to "OFF" position, remove the fuel filter cup, drain off the fuel in the cup. (Model: Simple unit)

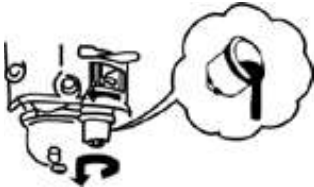

8-2. Turn on the fuel cock, drain off the fuel in the fuel tank. (Model: Simple unit)



8-3. Reinstall the fuel filter cup with a new O-ring. (Model: Simple unit)

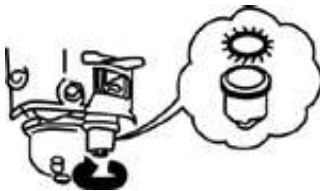

8-4. Loosen the carburetor's drainplug and drain off the fuel in the fuel Tank. (Model: unit)

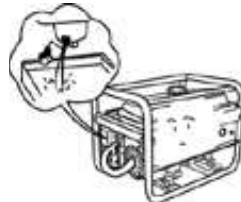

8-5. Loosen the oil drain plug and dipstick, dipstick, drain off the engine oil.



8-6. Reinstall the drain plug and dipstick.



8-7. Pull the starter handle gently until resistance is felt.

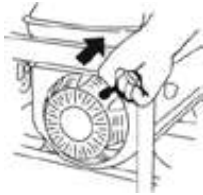

9. TROUBLES SHOOTING

9-1. Starting failure



① Is the engine switch at "ON" position?

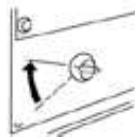

(Model: unit)



(Model: Simple unit)

② Is the oil level too low?



③ Is there enough the fuel?



④ Check the spark plug.



(Model: unit)



(Model: Simple unit)

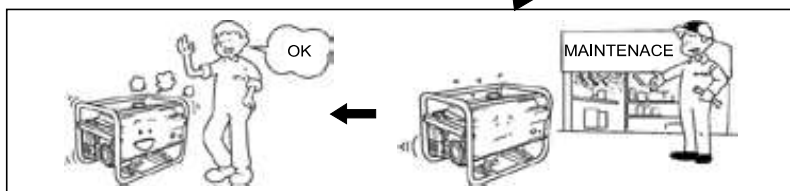

9-2. Appliance do not work

① Check the appliance device.



② Is the BREAKER at "ON" position?

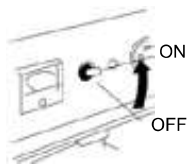

(Model: unit)

③ Is the AC protector reset at "ON" position?



(Model: Simple unit)

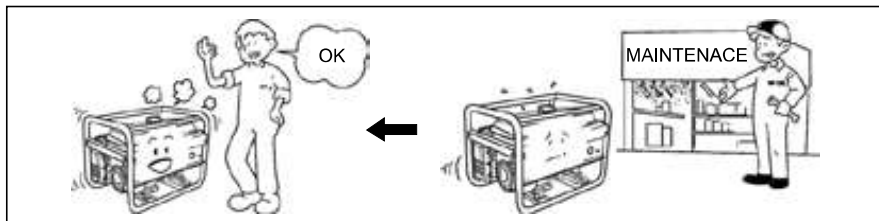

10. ELECTRIC DIAGRAM

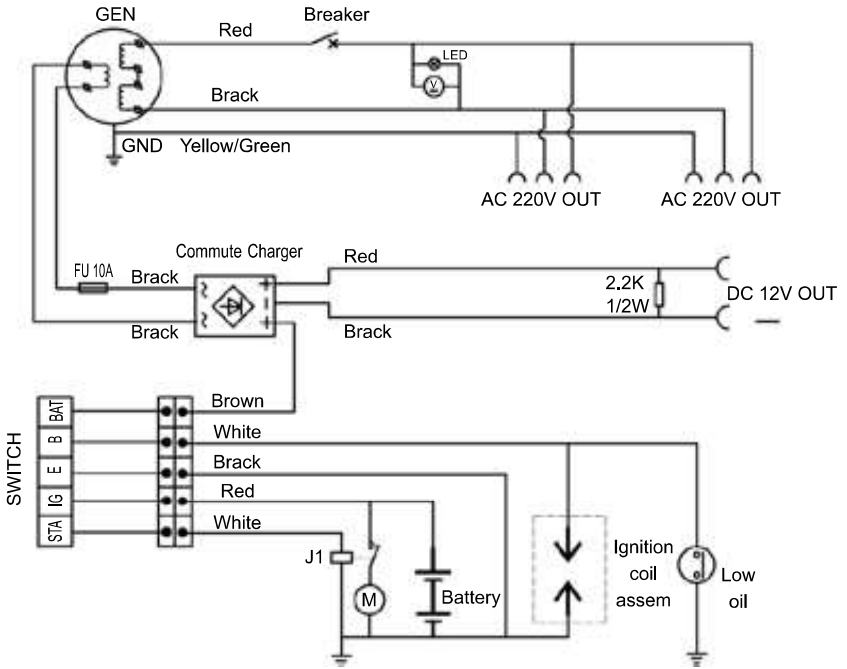

SWITCH

	IG	BAT	STA	E	B
OFF				● — ●	
ON	● — ●				
START	● — ● — ●				

Technical Data	KGL3500C	KGL3500CE	KGL8000CE	KGL8000CE3
Standby Power (kVA)	3,5	3,5	8,1	8,1
Prime Power (kVA)	3,1	3,1	7,5	7,5
Rated Current (A)	10,8	10,8	26	10,8
Phase	Single Phase			3-Phase
Power Factor	0,8			
Output Voltage (V)	230	230	230	230/400
Frequency (Hz)	50	50	50	50
Hour Meter	N/A	N/A	Digital	Digital
Engine	1 Cylinder, Air-Cooled, 4-stroke Gasoline Engine			
Engine Code	210	210	420	420
Engine Output (hp)	7	7	16	16
Displacement (cc)	208	208	420	420
RPM	1500	1500	1500	1500
Starting Method	Recoil	Recoil / Electric		
Fuel Type	Unleaded Gasoline			
Fuel Tank Capacity (lt)	15	15	25	25
Fuel Consumption (lt/hr)	1,3	1,3	2,6	2,6
Oil Capacity (lt)	0,6	0,6	1,1	1,1
Oil Type	15W40	15W40	15W40	15W40
Noise Level (dBA-7m)	68	68	76	76
Canopy Type	Open Type			
Weight (kg)	39	43	77	77

NOTES

KAMA *by* **REIS**

BENZİNLİ JENERATÖR SETİ GASOLINE GENERATOR SETS

MONOFAZE / SINGLE PHASE (220V)

KGL3500C, KGL3500CE, KGL8000CE

TRİFAZE / 3-PHASE (400V)

KGL8000CE3



reismakina

Türkiye Genel Distribütörü

Reis Makina Tic. ve San. A.Ş.

Abdurrahmangazi Mah. Ebubekir Cad.

İmamoğlu Sok. NO:2 34887

Samandıra / Sancaktepe / İSTANBUL / TÜRKİYE

T. +90 444 73 47 (REIS)

F. +90 (216) 561 46 88

E. info@reismakina.com

W. www.reismakina.com